



DEKBOARD[®]
decking and balustrade systems



Includes
**4 NEW
COLOURS**

www.dekboard.co.uk

THE RANGE GUIDE
it's great outdoors

DEKBOARD

A BEAUTIFUL DECKING AND BALUSTRADE SYSTEM, SPECIALLY DESIGNED TO REPLACE AND OUT PERFORM TRADITIONAL TIMBER DECKING

DekBoard is made to look and feel like high quality timber and do that without the need for the time consuming and costly maintenance that timber always needs.

DekBoard gives you a secure foothold in the wet or dry. It doesn't encourage the growth of slippery lichen and it is so easy to clean.

With DekBoard you can create a safe, secure and long-lasting outdoor space for rest, play and getting together.

It's a decking and balustrade system that will increase the usable area around your home, where you can set up patio furniture, or a small forest of pot plants, or sunbathe, or throw a party; or where you just take off your boots before going indoors.

CONTENTS:

Arena Decking	4 - 5
Horizon Balustrade	6 - 13
Post	6 - 7
Handrails	8 - 9
Pickets	10
Brackets	11
Glass	12
Gates	13
Project Planner	14-15

All instructions and suggestions in this document are given for guidance only and the installer should satisfy themselves that their planned deck will be safe given their individual circumstances and requirements.

Dekboard has taken every care to ensure that the information contained in this Guide is correct at time of publication.

THE DEKBOARD SYSTEM

Sub-frame Bracket

Decking Sub-frame (see page p3)

Glass Fixing Bracket

Glass Panel

6" Picket for Skirting





Post Cap

Brackets

Top Rail

Post

Picket

Gate

Bottom Rail

Installation

- Always use treated timber to maximise the life of the sub-frame.
- Bearers should be C16 grade timber of a nominal size 2" x 6" (45mm x 145mm). The notes below apply to this specification.
- Generally bearers run with the line of most traffic so that the decking boards run across the line. This must be observed with ramps, walkways and steps.
- Do not exceed maximum centres between bearers of 450mm for normal domestic loads. Centres of 400mm are recommended
- A support leg should be installed at maximum every 2.4m along the bearer.
- Install a minimum of one line of noggins across the centre of every span up to 2.4m. Larger spans should have noggins every 1200mm (max). Inserting more lines of noggins creates greater rigidity and strength.
- Always offset joints between longer lengths of decking by at least 2 bearers (900mm).
- Always ensure adequate through ventilation beneath the deck, especially when using darker deck colours.



ARENA DECKING

A great range of practical PVC decking boards with a traditional woodgrain pattern.



HORIZON BALUSTRADE

A traditional balustrade system that will complement Arena decks.



ARENA

A GREAT RANGE OF VERY PRACTICAL PVC DECKING BOARDS WITH A TRADITIONAL WOODGRAIN EFFECT PATTERN.

DekBoard Arena boards are practical, tough and durable. If you want a decking area that can take on all comers, then Arena is a great choice.

These boards are durable enough for kids to play on during the day and tough enough for adults to party on at night.

The board's satin finish is embossed for good slip resistance and the surface is easy to clean, whether it's kids or adults you're clearing up after.

Arena has a great range of contemporary and neutral colours that go well with most settings and complement the Horizon balustrade range.

ARENA DECKING

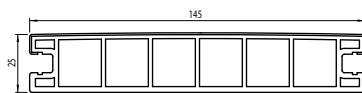

Light Oak



Dark Oak



Moss Grey



Driftwood



Luna Grey

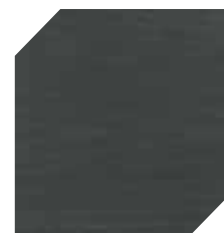

Anthracite Grey

Code	Colour	Length (m)
DDBP4902LO	Light Oak	4.902
DDBP4902DO	Dark Oak	4.902
DDBP4902MG	Moss Grey	4.902
DDBP4902DW	Driftwood	4.902
DDBP4902LN	Luna Grey	4.902
DDBP4902AG	Anthracite Grey	4.902

Deck Clip



Use Wood Screw Countersunk (DWSCREW30) P7

Code	Size	Pack
DCLIP50	40mm x 33mm	Bag 50
DCLIP250	40mm x 33mm	Box 250

Infill Trim

This trim clips neatly into the exposed edge of the outer board and can be used along the appropriate edge of the deck or along the front edge of a step.



Code	Colour	Length (m)
DINFILL3000LO	Light Oak	3.0
DINFILL3000DO	Dark Oak	3.0
DINFILL3000MG	Moss Grey	3.0
DINFILL3000DW	Driftwood	3.0
DINFILL3000LN	Luna Grey	3.0
DINFILL3000AG	Anthracite Grey	3.0

Edge Trim

A very useful trim for edging boards or steps.



Code	Colour	Length (m)
DEDGE4902LO	Light Oak	4.902
DEDGE4902DO	Dark Oak	4.902
DEDGE4902MG	Moss Grey	4.902
DEDGE4902DW	Driftwood	4.902
DEDGE4902LN	Luna Grey	4.902
DEDGE4902AG	Anthracite Grey	4.902

D Trim

A great looking, heavy duty profile for use as a starter trim - where a deck clip cannot be inserted to hold the leading edge of the first board - or to cover the exposed ends of boards around the edge of the deck.



Code	Colour	Length (m)
DDTRIM4902LO	Light Oak	4.902
DDTRIM4902DO	Dark Oak	4.902
DDTRIM4902MG	Moss Grey	4.902
DDTRIM4902DW	Driftwood	4.902
DDTRIM4902LN	Luna Grey	4.902
DDTRIM4902AG	Anthracite Grey	4.902

GENERAL ACCESSORIES

U-Channel

(29mm x 29mm x 29mm)



Code	Colour	Length (m)
DCHAN4876W	White	4.876
DCHAN4876AL	Almond	4.876
DCHAN4876_ _ *	Foiled	4.876

Fixed Angle

(40mm x 40mm)



Code	Colour	Length (m)
DFANG6000W	White	6.0
DFANG6000AL	Almond	6.0
DFANG6000_ _ *	Foiled	6.0

*add colour code from swatches below

*Colour codes: Golden Oak=GO, Anthracite Grey=AG, Forest Green=FG

HORIZON

A TRADITIONAL BALUSTRADE SYSTEM THAT WILL COMPLEMENT ARENA DECKS.

It is important to have a balustrade in order to keep children safe and avoid falls in general.

DekBoard Horizon balustrades can be made up in a number of ways using traditional top and bottom rails with pickets in square or diamond format, or with glass panels instead.

The hand rail and bottom rails should be reinforced with a metal insert that makes them very rigid and therefore able to take a lot of pressure from the side or above.

Glass panels are becoming popular and the Horizon range provides for clear and tinted toughened glass versions which can be mounted to your deck in a number of ways.

Please consult the section on balustrade height to determine the right height for your installation.

POSTS

- Always use a timber infill for posts of at least 95 x 95mm. Post infills may also be made up of 2 x 47mm x 95mm sections screwed together.
- Where the post is to be secured into a concrete or substantial timber base a Post Mount (DPOSTM) may be used (p7)
- Timber post infills should be set into concrete or mounted on to well set and well drained concrete or stone pads.
- Always treat the exposed end grain of such posts for long term protection.
- Remember to slide the post sleeve over the timber post infills prior to fixing the deck sub-frame to the posts.
- Bearers may be screwed either directly to timber filled posts or indirectly using a Sub-Frame Bracket (p7)

Post Sleeve

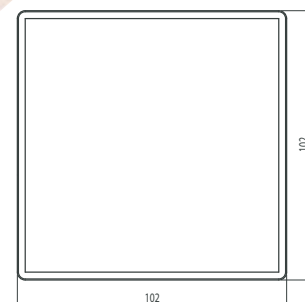

Code	Colour	Length (m)
DPOST1828W	White	1.828
DPOST1828AL	Almond	1.828
DPOST1828_*	Foiled	1.828
DPOST4876W	White	4.876
DPOST4876AL	Almond	4.876
DPOST4876_*	Foiled	4.876

*add colour code from swatches below

Post Cap

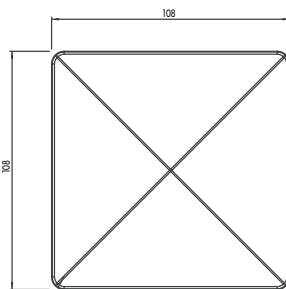
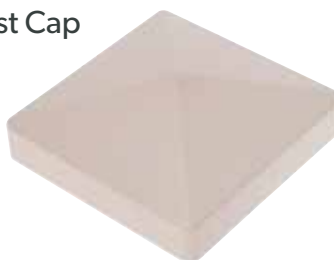

Code	Colour
DPOSTCW	White
DPOSTCAL	Almond
DPOSTC_*	Foiled

*add colour code from swatches below

Post Skirt

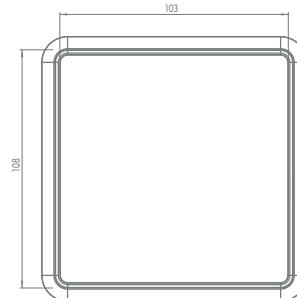

Code	Colour
DPOSTSW	White
DPOSTSAL	Almond
DPOSTS_*	Foiled

Standard

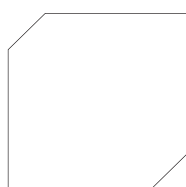

White (W)



Almond (AL)

Foils



*Golden Oak (GO)



*Anthracite Grey (AG)



*Forest Green (FG)

Post Mount

Mark the location of the corner holes on the lower mounting plate and drill a 10mm hole into the substrate for each of the 4 corners in order to accept a suitable M8 Fixing Anchor or appropriate concrete screws.

Set up the correct angle for the Post Mount by adjusting the 4 bolts threaded through the upper mounting bracket. Insert the anchors through the corner holes of both plates on the Post Mount as shown and press them into the substrate.

Once the final adjustment of the Post Mount position has been achieved ensure the anchors are bolted down and the lock nuts on the adjusting bolts are tightened up against the underside of the upper mounting plate.

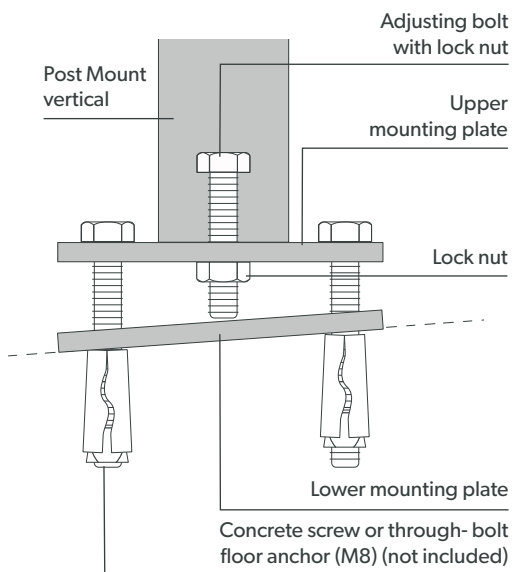

Code	length (m)
DPOSTM	0.76

Sub Frame Bracket

DEKBOARD®
decking and balustrade systems

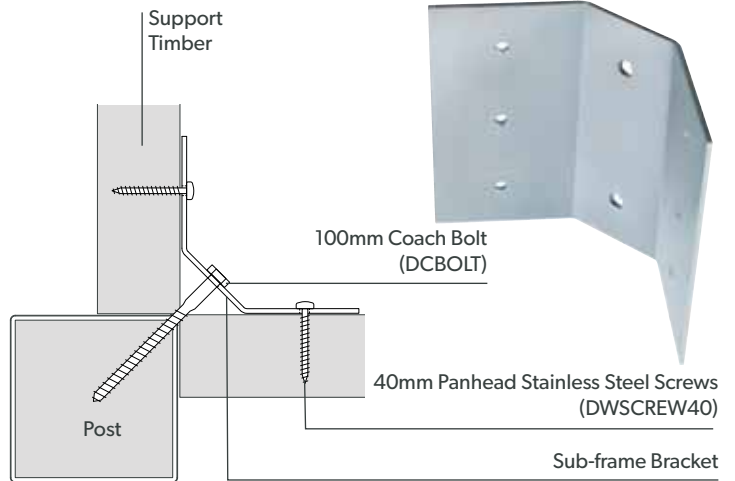

This bracket is used to secure the open corners of a sub-frame to a corner post.

Code	Size
DSUBBKT	100mm x 300mm

Deck Clip



The deck must be supported by bearers and a deck clip used on each bearer at maximum centres of 450mm. Deck clips should be secured using 4.5mm x 30mm Stainless Steel counter sunk screws (Code - DWSCREW30). Where decking boards are not set at 90degrees to the bearers the fixing centres of the decking board will naturally increase. This should be accounted for in bearer spacing in that area.

Code	Size	Pack
DCLIP50	40mm x 33mm	Bag 50
DCLIP250	40mm x 33mm	Box 250

Fixings

	Code	Unit	Application	Notes
Coach Bolt (100mm)	DCBOLT	Box 50	Sub Frame Bracket to Post	13mm head Stainless Steel
Wood Screw Countersunk (90mm)	DWCREW90	Box 100	General subframe assembly	Yellow plated- no pilot hole required (60mm of thread)
Wood Screw Countersunk (60mm)	DWCREW60	Box 200	Fascia board to subframe Fix deck from below	Yellow plated- no pilot hole required
Wood Screw Pan Head (40mm)	DWCREW40	Box 100	Sub-frame bracket to frame	Stainless steel
Wood Screw Countersunk (30mm)	DWCREW30	Box 500	Deck Clips Fixed Position Rail Brackets	Stainless Steel

DEKBOARD HORIZON BALUSTRADE SYSTEM

Routing – Top and bottom rails can be supplied in plain or routed format ready to accept the 1.25" picket. The holes can be routed square with the rail or at 45 degrees to the rail to form a diamond shape, or routed for glass panels if you prefer not to use our glass mounting brackets on p12.

Square - RS



Diamond - RD



Glass - RG



Top Rail Plain and Routed

It is recommended that rail reinforcement is used on all top and bottom rails

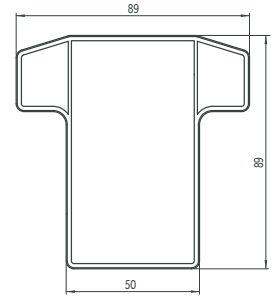

Code Square Rout	Code Diamond Rout	Code Glass Rout	Code Plain - No Rout	Colour	Length (m)
DTRAILRS1220W	DTRAILRD1220W	DTRAILRG1220W	DTRAIL1220W	White	1.220
DTRAILRS1220AL	DTRAILRD1220AL	DTRAILRG1220AL	DTRAIL1220AL	Almond	1.220
DTRAILRS1220_*	DTRAILRD1220_*	DTRAILRG1220_*	DTRAIL1220_*	Foiled	1.220
DTRAILRS1828W	DTRAILRD1828W	DTRAILRG1828W	DTRAIL1828W	White	1.828
DTRAILRS1828AL	DTRAILRD1828AL	DTRAILRG1828AL	DTRAIL1828AL	Almond	1.828
DTRAILRS1828_*	DTRAILRD1828_*	DTRAILRG1828_*	DTRAIL1828_*	Foiled	1.828
DTRAILRS2438W	DTRAILRD2438W	DTRAILRG2438W	DTRAIL2438W	White	2.438
DTRAILRS2438AL	DTRAILRD2438AL	DTRAILRG2438AL	DTRAIL2438AL	Almond	2.438
DTRAILRS2438_*	DTRAILRD2438_*	DTRAILRG2438_*	DTRAIL2438_*	Foiled	2.438
-	-	-	DTRAIL4876W	White	4.876
-	-	-	DTRAIL4876AL	Almond	4.876
-	-	-	DTRAIL4876_*	Foiled	4.876

*add foil colour code from swatches on p9

HEIGHT OF BALUSTRADES

Balustrades on decks can serve several functions, ranging from simple decorative boundaries to full safety barriers.

Even a small change of level can be a hazard, particularly for elderly or infirm users. Unless the deck surface is flush with the surrounding ground, a balustrade should be incorporated.

The height of the balustrade depends on how far the deck surface is off the ground:

For 'low-level' structures where the deck surface is up to 600mm from ground level, the hand rail height should be a minimum of 900mm above the deck surface.

For 'high-level' decks over 600mm high the balustrade height should be a minimum of 1100mm above the deck surface.

DekBoard standard balustrade components have been designed to meet the requirements for low-level structures. For high-level structures the picket height should be increased to at least 960mm.

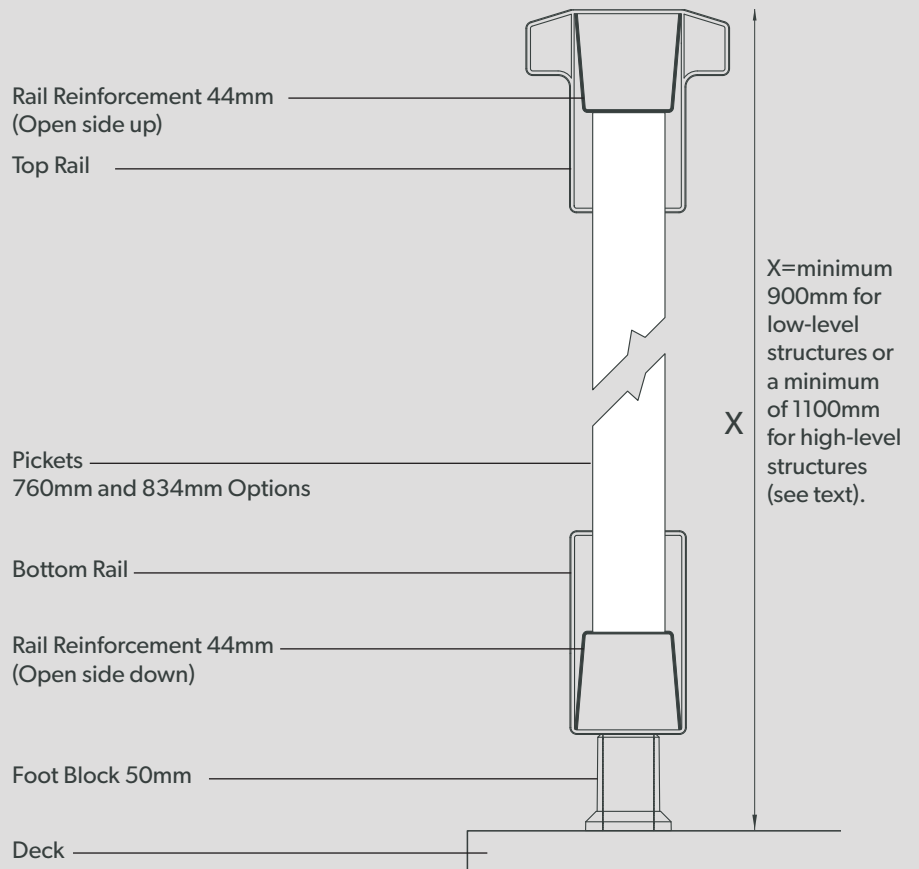

Bottom Rail Plain and Routed

It is recommended that rail reinforcement is used on all top and bottom rails

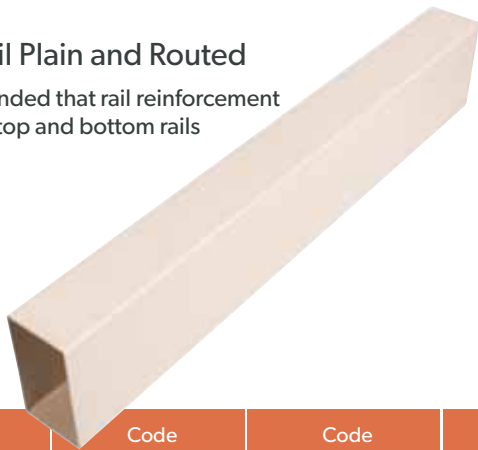

Standard

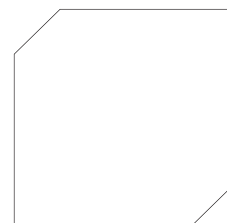

White (W)

Foils



*Golden Oak (GO)



Almond (AL)



*Anthracite Grey (AG)



*Forest Green (FG)

Code Square Rout	Code Diamond Rout	Code Glass Rout	Code Plain - No Rout	Colour	Length (m)
DBAILRS1220W	DBAILRD1220W	DBAILRG1220W	DBAIL1220W	White	1.220
DBAILRS1220AL	DBAILRD1220AL	DBAILRG1220AL	DBAIL1220AL	Almond	1.220
DBAILRS1220_*	DBAILRD1220_*	DBAILRG1220_*	DBAIL1220_*	Foiled	1.220
DBAILRS1828W	DBAILRD1828W	DBAILRG1828W	DBAIL1828W	White	1.828
DBAILRS1828AL	DBAILRD1828AL	DBAILRG1828AL	DBAIL1828AL	Almond	1.828
DBAILRS1828_*	DBAILRD1828_*	DBAILRG1828_*	DBAIL1828_*	Foiled	1.828
DBAILRS2438W	DBAILRD2438W	DBAILRG2438W	DBAIL2438W	White	2.438
DBAILRS2438AL	DBAILRD2438AL	DBAILRG2438AL	DBAIL2438AL	Almond	2.438
DBAILRS2438_*	DBAILRD2438_*	DBAILRG2438_*	DBAIL2438_*	Foiled	2.438
-	-	-	DBAIL4876W	White	4.876
-	-	-	DBAIL4876AL	Almond	4.876
-	-	-	DBAIL4876_*	Foiled	4.876

*add foil colour code from swatches right

Bottom Rail Routed for 6" Picket/Facing Board

Code	Colour	Length (m)
DBAIL6R4876W	White	4.876
DBAIL6R4876AL	Almond	4.876
DBAIL6R4876_*	Foiled	4.876

*add foil colour code from swatches right

Rail Reinforcement

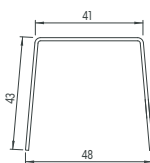

Code	Length (m)
DRBAR1828	1.828
DRBAR2438	2.438

Foot Block

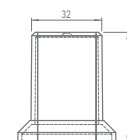

Code	Colour	Size
DFTBLKW	White	32mm x 50mm
DFTBLKAL	Almond	32mm x 50mm
DFTBLK_^	Solid Colour	32mm x 50mm

^ Tan (T), Anthracite Grey (7016)

DEKBOARD HORIZON BALUSTRADE SYSTEM

1.25" Picket

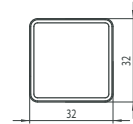

Code	Colour	Length (m)
DPICK10760W	White	0.76
DPICK10760AL	Almond	0.76
DPICK10760_*	Foiled	0.76
DPICK10834W	White	0.834
DPICK10834AL	Almond	0.834
DPICK10834_*	Foiled	0.834
DPICK15100W	White	5.1
DPICK15100AL	Almond	5.1
DPICK15100_*	Foiled	5.1

*add foil colour code from swatches left

6" Picket for Skirting

The Facing/Skirting Board is used for facing off the edge of the deck in order to hide the timber bearers. The boards can be secretly fixed from behind using 60mm woodscrew DWSCREW60 (p7) assuming that the timber substructure is at least 40mm deep. In addition it can be mounted vertically or horizontally under the deck to form a screen or skirt that hides the full deck substructure. Always leave gaps between boards for ventilation.

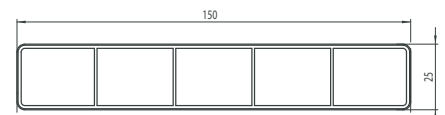

Code	Colour	Length (m)
DPICK64876W	White	4.876
DPICK64876AL	Almond	4.876
DPICK64876_*	Foiled	4.876
DPICK6PF4876_*	Part Foiled	4.876

PF in the code denotes Part Foiled (three faces only).

*add foil colour code from swatches left

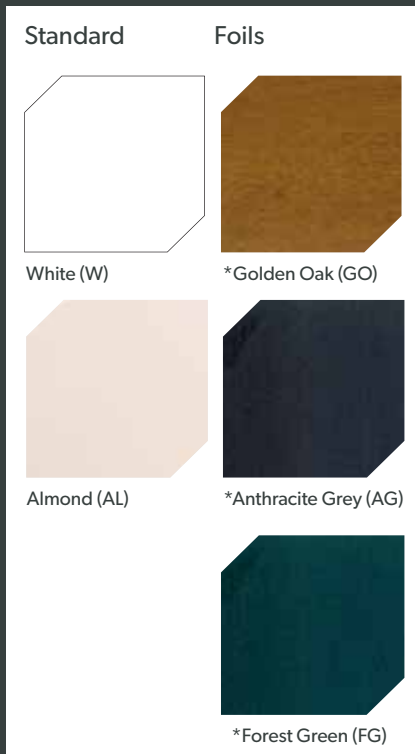

Note –

- Fix the lower section of each bottom bracket in position first, ensuring that they are level. Pre-assemble the rails, reinforcing bar, and pickets (p10), set them into the bottom rail brackets and mark the position for the top rail brackets. Remove the rail assembly, fix the top rail brackets in place and reinstall the rail assembly. The top sections of each bracket simply clip into place. A screw must be fixed into the hole in the bottom of the bracket.
- Always check that the top brackets are fixed at the required balustrade height

Top rail and bottom rail brackets are needed to fix the rails to the posts. Brackets are available as fixed position units in straight format, in 30deg (up or down) format or in multi angle (horizontal or vertical) format.

**Top Rail Bracket
Straight**



Code	Colour
DBTMBKTW	White
DBTMBKTAL	Almond
DBTMBKT__*	Foiled

**Bottom Rail Bracket
Straight**



Code	Colour
DBTMBKTW	White
DBTMBKTAL	Almond
DBTMBKT__*	Foiled

**Top Rail Stair
Bracket Kit 30°
1 x up 1 x down**



Code	Colour
DTSTAIRW	White
DTSTAIRAL	Almond
DTSTAIR__*	Foiled

**Bottom Rail Stair
Bracket Kit 30°
1 x up 1 x down**



Code	Colour
DBSTAIRW	White
DBSTAIRAL	Almond
DBSTAIR__*	Foiled

*add foil colour code from swatches on p10

**Universal Angle Top Rail & Bottom Rail
Horizontal (Kit) x4 units**



Code	Colour
DUAHW	White
DUAHAL	Almond



**Universal Angle Top Rail & Bottom Rail
Vertical (Kit) x 4 units**

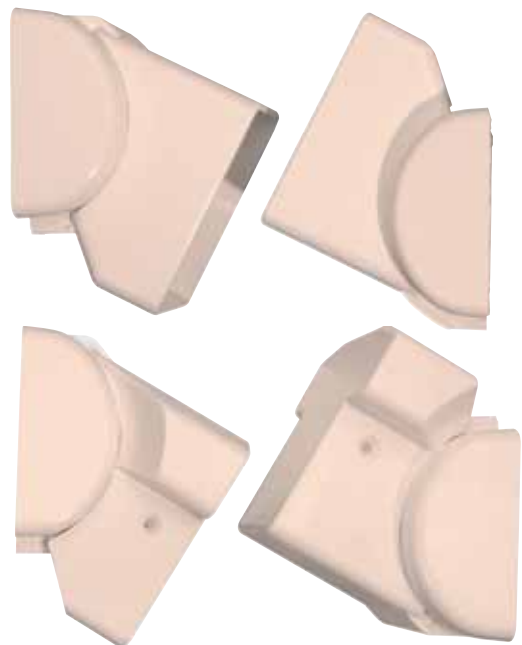

Code	Colour
DUAHV	White
DUAVAL	Almond



DEKBOARD GLASS

Toughened glass is up to five times stronger than regular glass. This is achieved by heating at high temperatures and cooling very quickly.

Toughened laminated glass has a plastic interlayer between 2 panes of glass holding them together. If one of the toughened glass panes does happen to break not only will there be no falling glass particles but the additional toughened glass pane and the interlayer will provide an extra barrier to prevent injury.

Glass



Toughened Glass

Code	Colour	Thickness	Length (mm)	Height (mm)
DGL864G	Clear	10mm	864	850
DGL1169G	Clear	10mm	1169	850
DGL1474G	Clear	10mm	1474	850
DGL1779G	Clear	10mm	1779	850

Code	Colour	Thickness	Length (mm)	Height (mm)
DGL864K	Smoked	10mm	864	850
DGL1169K	Smoked	10mm	1169	850
DGL1474K	Smoked	10mm	1474	850
DGL1779K	Smoked	10mm	1779	850

Toughened Laminated Glass

Code	Colour	Thickness	Length (mm)	Height (mm)
DGL864L	Clear	13.52mm	864	850
DGL1169L	Clear	13.52mm	1169	850
DGL1474L	Clear	13.52mm	1474	850
DGL1779L	Clear	13.52mm	1779	850

Bracket Sets for Glass



DGLC10



DGLC1352

Code	Colour	Glass Thickness	Brackets (Pack)
DGLC10	Stainless Steel	10mm	4
DGLC1352	Stainless Steel	13.52mm	4

GATES

We recommend that a gate is fitted to all raised deck platforms. With self-closing hinges and lockable latches these gates provide a safe enclosure for children and a deterrent to others.

The holes can be routed square with the rail or at 45° to the rail to form a diamond shape.



(Fittings not included)

Please contact us for available sizes and finishes.

HINGES

Pair of self-closing hinges to ensure that the gate always returns to a closed position. Super strong engineering polymer and stainless steel construction.



Code	Colour	Pack Qty
DHINGE	Black	1 pair

LATCH

Single side secure, key-lockable latch. Adjusts horizontally and vertically to account for any gate movement.



Code	Colour	Pack Qty
DLATCH	Black	1 pair

DEKBOARD

PLAN YOUR DECK

Use this handy space to plan your perfect deck. Start by drawing the area you'd like to deck out, and then work out the number of boards required.

Our board length is 4902mm and the width is 145mm. Each board has a 5mm gap between it and the next board (this gap is created by the decking clips), so the cover width is 150mm. Therefore, each board covers 0.735 of a square metre (ie approximately $\frac{3}{4}$ sqm).

To work out the number of boards that are required just calculate the number of square metres your deck will cover, then divide that number by 0.735

Example:

A deck of 5m x 4m has an area of 20sqm. The number of boards needed is $20 \div 0.735 = 27.2$ boards. You should also allow 12 to 14 decking clips per decking board.

Important – This calculation is an approximate guide. Very few decks are nicely rectangular and so you'll have to allow for odd areas that may require you to cut the boards in ways that create more wastage than this simple calculation allows for. Therefore you should allow for at least 10% wastage. In some circumstances it may be helpful to tailor the size of your deck to make the most of each board length.

Remember that the following basic principles of setting out the boards may affect the number of boards you'll need to use:

Run the boards across the most common line of tread, not with it.

Separate all joints on adjacent boards by at least 2 bearers

All deck pieces should be long enough to be secured to at least 3 bearers.

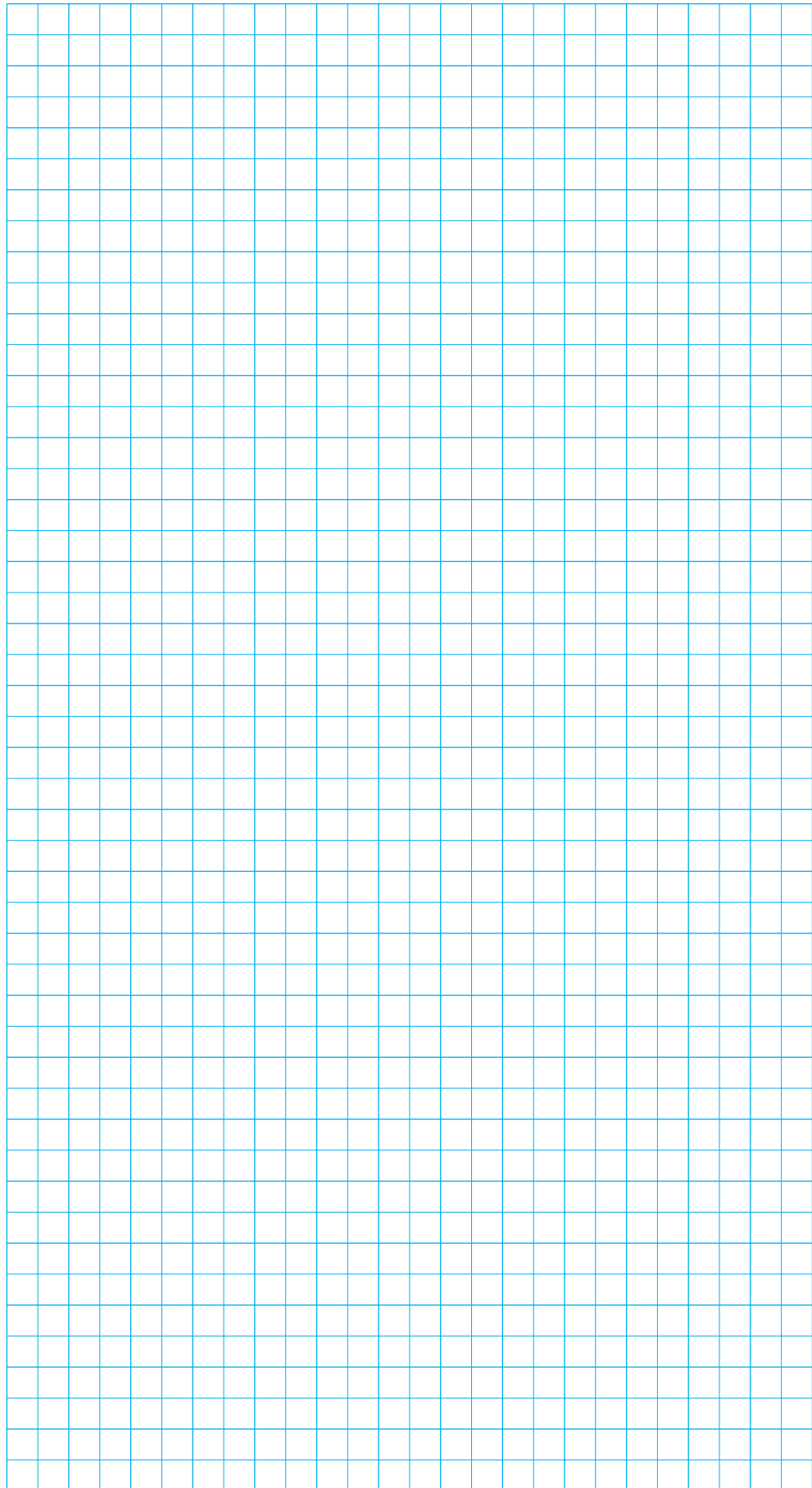

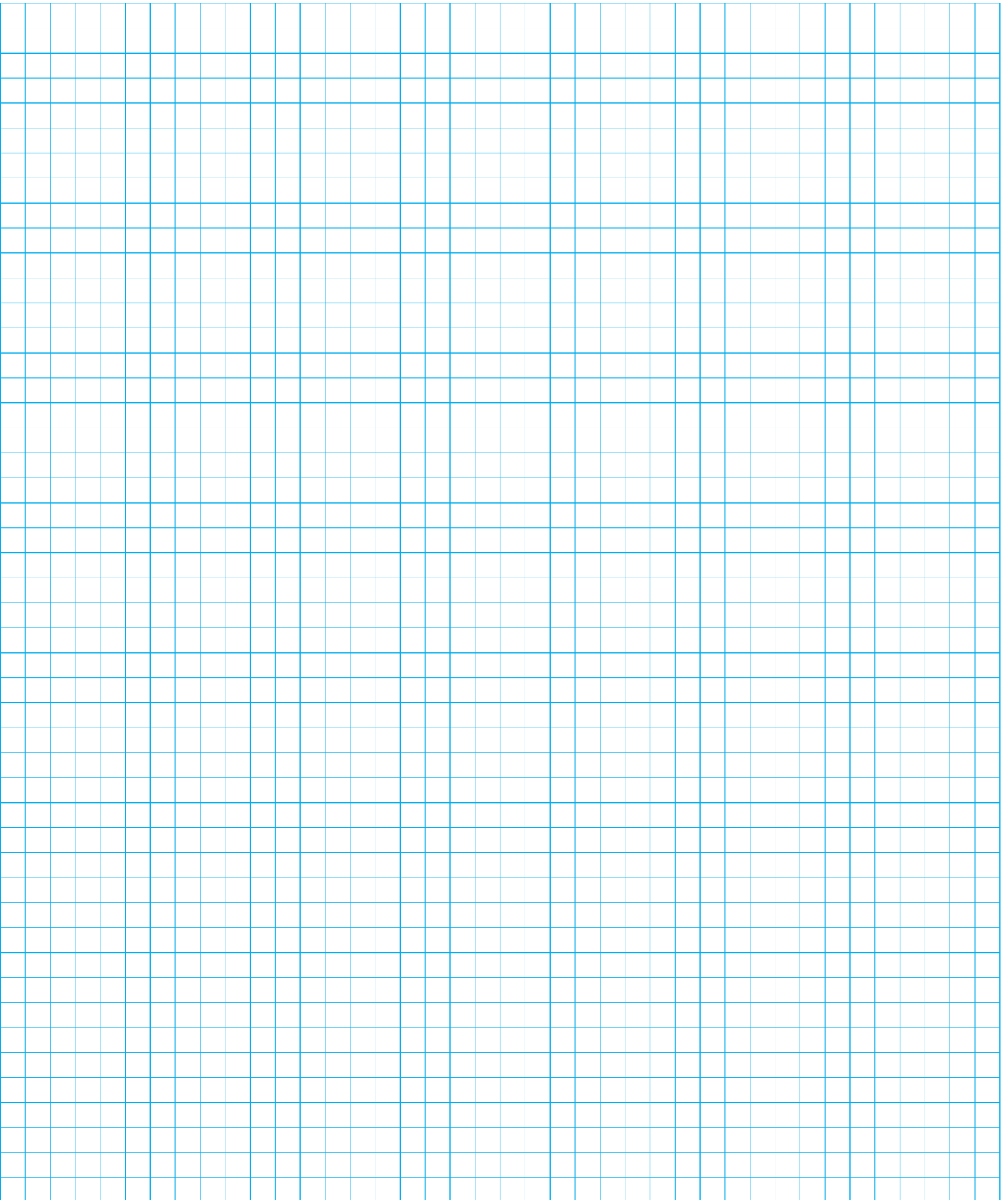



ROBUST

- Strong construction
- Wear & impact resistant
- Will not warp like timber
- Low sound levels



SAFETY

- Low slip surface in wet or dry conditions
- Will not crack or splinter
- Will carry high loads
- No sharp edges or splinters



LOW MAINTENANCE

- Easily cleaned
- Unlike timber it won't promote mould growth
- Doesn't need treating, varnishing or painting



ENVIRONMENTAL

- 100% Recyclable
- No paints or preservatives required
- Manufactured under ISO14001 Environmental Management Certification.



LONG LIFE

- Will not rot
- Does not require maintenance
- 20 year performance guarantee
- Outlasts timber



PRODUCT TESTING

- Fire Resistance – Tested to BS 476: Part 7
- Slip Resistance – Tested to BS7976 -2
- Static Load Capability – Tested to BS6399 Pt1

Due to the limitations of the printing process the swatches and photography in this brochure should be taken as a guide and not an accurate representation of the actual product colour.

DEKBOARD[®]
decking and balustrade systems

Billet Lane, Normanby Enterprise Park, Normanby Road,
Scunthorpe, North Lincolnshire DN15 9YH

t: 01724 848500 e: sales@dekboard.co.uk

www.dekboard.co.uk